

## MOBILE LABEL PRINTER RPP30

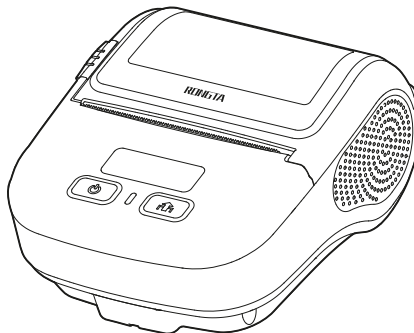

Please read this Manual carefully before using the printer and keep it for future reference

# Contents

---

---

<b>Preface</b> .....	<b>1</b>	<b>3.2 Power Off</b> .....	<b>15</b>
<b>Safety Instruction</b> .....	<b>2</b>	<b>3.3 FEED</b> .....	<b>15</b>
<b>I. Product introduction</b> .....	<b>5</b>	<b>3.4 Auto sleep/wake</b> .....	<b>15</b>
1.1 Product specification.....	5	<b>3.5 Icons Description</b> .....	<b>16</b>
1.2 Unpacking list.....	7	<b>3.6 Enter setting Screen</b> .....	<b>17</b>
1.3 Appearance and components .....	8	<b>3.7 USB Communication</b> .....	<b>18</b>
<b>II. Installation instructions</b> .....	<b>10</b>	<b>3.8 Bluetooth Communication</b> .....	<b>19</b>
2.1 APP download .....	10	<b>3.9 WiFi Communication</b> .....	<b>19</b>
2.2 Battery Installation .....	10	<b>IV. Repair and Maintenance</b> .....	<b>20</b>
2.3 Battery Charge.....	11	4.1 Daily Maintenance of Printer.....	20
2.4 Paper width adjustment for use .....	12	4.2 Use and Storage of Printing Paper.....	21
2.5 Printing paper roll installation .....	13	<b>V. Troubleshooting</b> .....	<b>22</b>
2.6 Belt buckle installation.....	14	<b>VI. FCC WARNING</b> .....	<b>23</b>
<b>III. Basic function instructions</b> .....	<b>15</b>	<b>VII. Battery recycling</b> .....	<b>24</b>
3.1 Power On.....	15		

# Preface

---

---

## About This Manual

Thank you for purchasing the RPP30 mobile printer produced by Rongta.

This Manual can help you easily learn to use this product. Please read this Manual carefully before using the printer and keep it properly so that everyone who uses this product can read it.

## Icons and Practices

For your convenience, this Manual uses the following symbols (icons) and practices:

 **WARNING** warns that improper use may result in property damage, serious injury or death.

 **ATTENTION** indicates that improper use may result in personal injury or property damage.

 **NOTE** indicates that the information listed allows you to use the product better or extend the service life of the product.

## Version record

Version number	Release date	Description
V1.0	2023.11	This is the first official release

 The illustrations and text used in this Manual may differ from the actual product.

## Safety Instruction

---

---

Please follow the following precautions when using the printer:



**ATTENTION**

Do not disassemble the printer by yourself. Please read this Manual carefully before use.



**WARNING**

Please turn off the power immediately in case of failure. When you notice smoke or odor coming from the printer or power adapter, please unplug the power adapter and remove the battery immediately. Please be careful not to get burnt.



**WARNING**

Please do not use the printer near gas stations, fuel warehouses and other flammable materials.



**WARNING**

During charging, the printer and power adapter must be placed in a ventilated place with the ambient temperature of 0°C - 45°C, and be sure to use the power adapter provided by the Company. The use of unapproved power adapters may be hazardous and also violates our warranty policy.



**ATTENTION**

When the printer is printing, please do not open the cover of the paper bin; otherwise, unpredictable conditions may occur and the printer may even be damaged.



**ATTENTION**

After printing, the print head is still at a high temperature. Do not touch it to avoid burns.



**ATTENTION**

Please do not use dissolved matter (such as benzene thinner) to wipe the printer shell, and please keep the printer away from corrosive chemicals. You can only gently wipe the printer with a clean soft cloth.









**ATTENTION**

Please use our original or approved printing paper; otherwise, it may lead to poor printing quality or even damage to the printer mechanism.













**WARNING**

The print head is a hot part. Do not touch the print head and its surrounding parts during or just after printing. Children must use it under adult supervision.







-  **WARNING** Do not touch thermal printhead surfaces and connectors. Avoid electrostatic damage to the print head.
-  **ATTENTION** If the printer is to be stored for a long time, be sure to remove the battery from the printer and store it separately; otherwise, the battery may fail or even have leakage, which may damage the printer.
-  **ATTENTION** Make sure the printer is turned off before replacing the battery. If a power adapter is used, make sure the power is cut off before replacing the battery.
-  **ATTENTION** The printer can work stably at an ambient temperature of 0°C - 40°C. Too high or too low ambient temperature will lead to low printing quality.
-  **ATTENTION** The time that the printed text can be kept on the thermal printing paper is related to the paper quality. To print documents that need to be kept for a long time, please use long-lasting thermal printing paper.
-  **ATTENTION** The tear blade has a sharp edge, please be careful not to touch to prevent cuts.

**Please follow the following precautions when using the battery:**

-  **ATTENTION** Please carefully read this Manual and symbols on the battery surface before use.
-  **WARNING** Please charge the battery in a cool and ventilated room. The high ambient temperature during charging will cause the battery to heat up, emit smoke, burn, deform, or even explode.
-  **WARNING** There are special protective circuits and devices inside the battery. Please do not disassemble the battery by yourself, or it will cause a short circuit or electrolyte leakage.
-  **WARNING** There is a risk of blindness if the electrolyte gets into the eye. In case of eye contact, rinse immediately with water and seek doctor's advice immediately.

-  **WARNING** Do not squeeze, mechanically vibrate or shake the battery, and short circuit of the battery is strictly forbidden.
-  **WARNING** Please do not put the battery into water; otherwise, it may result in internal short circuit, which may cause the battery to heat up, emit smoke, deform, damage or even explode.
-  **ATTENTION** Do not expose the battery to direct sunlight or put it in a place with excessive smoke and dust. Do not use the battery in a high humidity environment, such as a bathroom.
-  **ATTENTION** Please replace the battery if it cannot meet the performance requirements.
-  **ATTENTION** Keep the battery out of reach of children to prevent danger.
-  **ATTENTION** If you notice any discoloration or deformation of the battery, stop using it immediately.

**Please carefully read this Manual and symbols on the surface of power adapter before use.**

-  **ATTENTION** Do not disassemble or modify the power adapter. Do not use the power adapter if the power line is damaged; otherwise, it may cause electric shock, fire and damage to the power adapter.
-  **WARNING** Do not touch the power adapter with wet hands. If the power adapter comes into contact with water or other liquids, cut off the power supply immediately.
-  **WARNING** Please avoid short circuit, vibration or shaking of the power adapter.
-  **WARNING** Do not use the power adapter in a high humidity environment, such as a bathroom. The equipment is not waterproof and must not be exposed to rain or moisture.
-  **WARNING** Hold the power adapter body when unplugging. Simply pulling the power line will damage the wires.
-  **ATTENTION** Keep the power adapter out of reach of children to prevent danger.

# I. Product introduction



## 1.1 Printer Parameters







Printing Parameters	
Printing method	Thermal line printing
Print width	22~80mm
Paper roll diameter	≤ 50mm
Print speed	100mm/s MAX
Resolution	203dpi
Built-in font	GB18030 Simplified Chinese (standard)
Thermal head lifespan	≥50km (label paper)
Command set	CPCL/ESC
Support paper types	Thermal continuous paper, label paper, black label paper
Print content	One-dimensional code: Code 39, 39C, I25, Code 93, ITF25, EAN128, Code 128, Codabar, EAN-8, EAN8+2, EAN8+5, EAN-13, EAN13+2, EAN13+5, UPC-A, UPCA+2, UPCA+5, UPC-E, UPCE+2, UPCE+5 MSIC, ITF14, EAN14, CODE11, POST QR code: QR CODE, PDF417 (optional)

Printing Parameters	
Extended character list	CP437, CP850, CP852, CP860, CP863, CP865, CP866, WPC1250, WPC1251, WPC1252, WPC1253, WPC1254
Input power supply	Input AC 100-240V, output DC 5V  2A
Battery specification	7.4V 2000mAh lithium-ion battery
Charging time	3 hours
Wireless communication	Bluetooth 5.0- Dual mode (compatible with Android and iOS)
Wire communication	Type-C USB
Working environment	Temperature: -10°C~50°C Humidity: 5%~95%(No condensation)
Storage environment	Temperature: -20°C~60°C Humidity: 5%~90%(No condensation)

 **Note:** This product information parameters are subject to change without prior notice, subject to the actual!

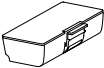

## 1.2 Unpacking list

Printer	USB cable	Power adapter	Quick installation guide
			
Battery	Roll	Belt buckle	
			

☺ The pictures are for reference only, please subject to practicality

## 1.3 Appearance and components

### □ Front View

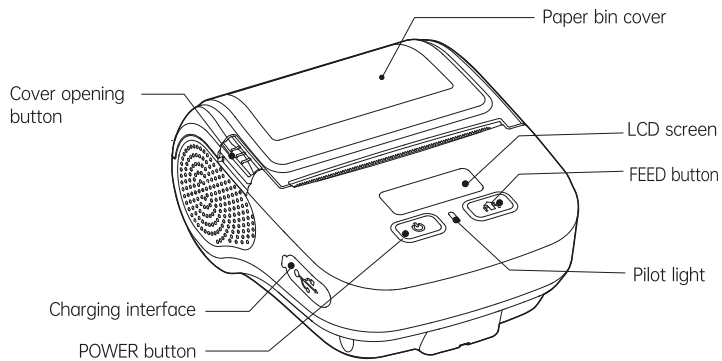

## ❑ Inside View

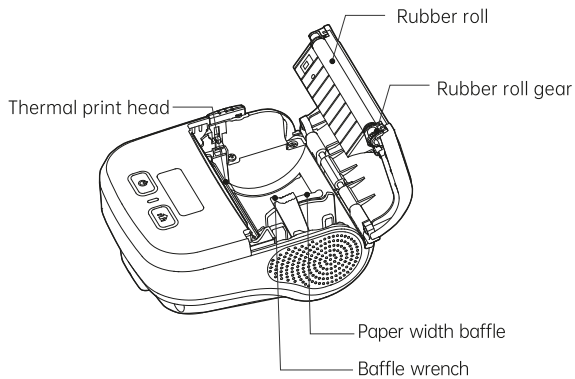

## ❑ Rear View

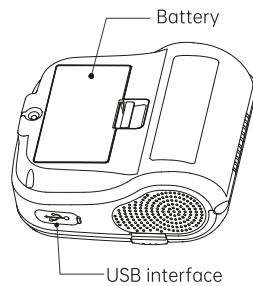

## II. Installation instructions



Tips: It is recommended to tear off the LCD screen protective film before use!

### 2.1 APP download

- (1) Android customers, please scan the QR code on the right side to download and install the APP;
- (2) For the iOS client, search "Elabel" in the APP Store to download and install it.



Android APP Download

### 2.2 Battery Installation

- (1) When installing or removing the battery, make sure the printer is powered off.
- (2) As shown in Figure 1 below, insert the battery into the battery slot behind the printer in the direction of the arrow. Press down on the battery until the card snaps into place, as shown in Figure 2 below
- (3) as shown in Figure 2 below, when removing the battery, open the battery latch, using the opposite steps to install the battery.

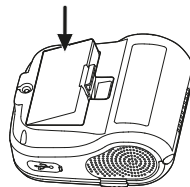

Figure 1

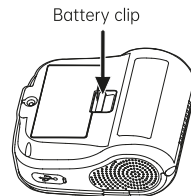

Figure 2

## 2.3 Battery charge

### (1) Standby charging

Insert the power adapter plug into the power socket, and the USB interface into the printer charging port(AC:100V~240V(50/60Hz)).

Charging: Battery indication icon  scroll display of battery indication slot.

End of charging Battery indication icon shows  full battery,

The buzzer will alert with a "beep" sound.

#### WARNING

If you use a power adapter not provided or approved by us, the printer may be damaged.

#### NOTE

It can be printed while charging.

The device supports the fast charge function, which can continue to print after a short charge.

#### ATTENTION

Do not remove the battery while charging.

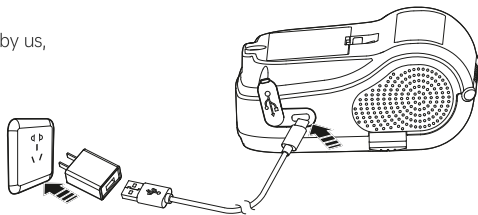

## 2.4 Paper width adjustment for use

Baffle wrench upward: lock paper width adjustment;

Baffle wrench down: unlock the paper width adjustment.

Unlocking the paper width adjuster can adjust the paper width as follows:

- (1) Adjust the paper width according to the paper width, hold the top of the paper width baffle and move it to the left (as shown in Figure 1).
- (2) Place the paper roll by hand and move the bottom part of the paper width adjustment block to the left (Figure 2)

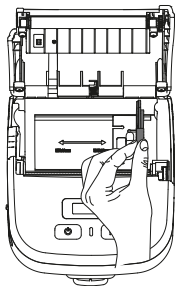

Figure 1

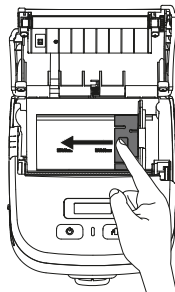
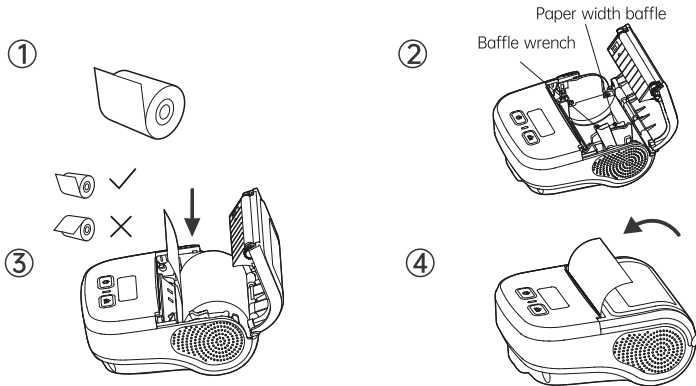

Figure 2

## 2.5 Printing paper roll installation

- (1) Remove the seal of the paper roll;
- (2) Press the open button to open the paper compartment, turn the baffle wrench to unlock, and adjust the paper width baffle to the paper width;
- (3) Put the paper roll into the paper bin, fine-tune the paper width baffle to lean against the paper roll, turn the paper width baffle wrench to fix it;
- (4) Pull out a part of the paper along the exit and close the paper bin cover.



### NOTE

- (1) Printers use paper specifications: paper width: 20~80mm (adjustable on one side), paper roll diameter: 50mm.
- (2) Pay attention to the direction of paper roll. If it is placed in the wrong direction, it will lead to blank printing.

## 2.6 Belt buckle installation

- (1) Remove the belt buckle
- (2) Tighten the belt buckle screws as shown in the following figure

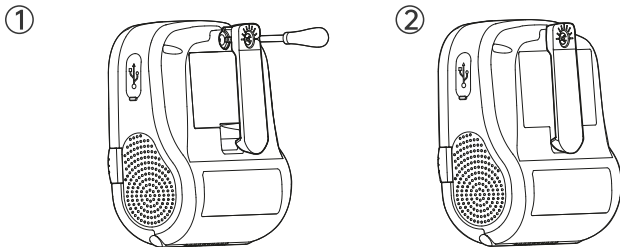



## III. Basic function instructions

---



### Function description of buttons

#### 3.1 Power On

Long press [Power button] for 3 seconds

#### 3.2 Power Off

When the printer is turned on,  
long press [Power button] for 3 seconds

#### 3.3 FEED

Short press [FEED button] (press [FEED button] in continuous paper mode, the paper moving is about 10mm.  
In label/Black label mode, press the [FEED button] to move the paper to the seam mark or to the black mark)

#### 3.4 Auto sleep/wake

##### Auto sleep







When the printer is turned on, there is no key operation or data transmission within 10 seconds, the printer will automatically enter the sleep state, press the power button or the paper key to wake up the printer



##### Auto wake

The printer will wake up automatically when the data is received

### 3.5 Icons Description

Paper shortage state	 Insert Paper	When paper shortage occurs or the paper roll is not properly loaded
Cover opening state	Close Cover	When the r paper bin cover is not closed or not properly closed
Battery indication		When charging, the icon will scroll to indicate the charging status
Bluetooth indicator		Printer with Bluetooth function, this icon shows. (  indicates successful Bluetooth connection)
WiFi indicator(Optional)		Printer with wireless function, this icon shows. (  indicates successful WiFi connection)

### 3.6 Enter setting Screen

In the startup state, press [Power button] and [FEED button]

at the same time to enter the main menu of the system.

Press [Power button] to select a function menu item.

Short press [FEED button] : change the function parameters.

Long press [FEED button] : confirm the setting and exit.



Print self-test page	Press the [FEED button] to start printing the self-test page and exit the menu
Mark/None/Gap	Set paper type
Label learning	For current paper learning
0-4	Set a small range of clarity
0-4	Set a wide range of clarity
0-5	Set print speed
Open/Close	Set whether to enable the buzzer
Open/Close	Set whether to turn on the boot paper
Open/Close	Set whether to open and close the cover paper
Screensaver time 10s/30s/60s/99s	Set the screensaver time
Automatic shutdown - /1-5 hours	Set automatic shutdown
中文/English	Set language
CPCL/ESC	Instruction mode setting
58/80	Set paper size (for ESC instruction only)
Return to main screen	

### 3.7 USB Communication

The printer provides USB port, which is used to connect the printer to a PC as shown in the figure to charge the printer, set parameters, and transmit data, etc.

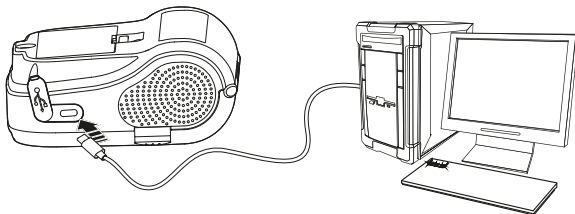

### 3.8 Bluetooth Communication

Bluetooth Name: RPP30-XXXX(last four digits of Bluetooth address)

Bluetooth password: Default 0000

1. Android phone first find the device in the Bluetooth list of the phone, click connect, and then connect with the APP.
2. The iPhone can be directly connected in the APP, and the interface of connecting the printer will be displayed when printing; If the input password page appears, please enter the Bluetooth password: 0000.

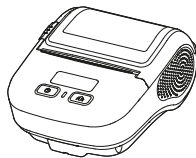

### 3.9 WiFi Communication (Alternative)

The mobile label printer can provide WiFi communication, and support STA mode and TPK/AES encryption. Its effective communication distance is no more than 20m.

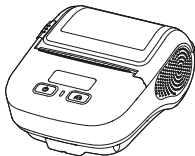

- WiFi information can be changed through the setting tool. For details, please refer to the "Instruction Manual for Setting Tool".

## IV. Repair and Maintenance



### 4.1 Daily Maintenance of Printer

(1) print head, roller must be cleaned regularly, especially when the print blur quality decreases,

The steps to clean the print head are as follows:

- Turn off the power of the printer, open the cover, if there is paper, remove the paper;
- If you have just finished printing, wait for the print head to cool completely;
- Wipe the dust and stains on the surface of the print head with a soft cotton cloth dipped in alcohol;
- Wait until the alcohol is completely volatilized, close the upper cover, and re-test the printing machine.

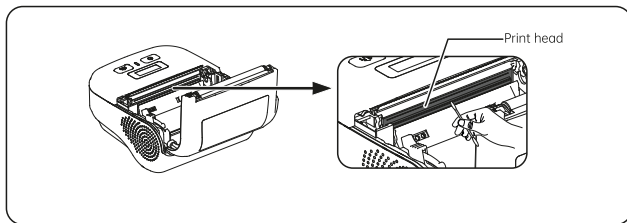

Use a cotton wool dampened with anhydrous alcohol to gently wipe the print head on the right, marked with gray boxes

**The steps to clean the roller are as follows:**

- (1) Turn off the power of the printer and open the top cover;
- (2) Wipe the printing roller with a soft cotton cloth dipped in neutral alcohol/Dust and stains on the surface;
- (3) After the alcohol is completely volatilized, close the top cover.

2. if you find water inside the printer, please immediately shut down and take out the battery, and the printer naturally dry.
3. if you do not use the printer for a long time, please take out the battery and store it separately.
4. the printer outside and paper bin cleaning: please use a dry wet cloth gently wipe the printer surface and paper bin inside, pay attention to the wet cloth must be completely wrung out.

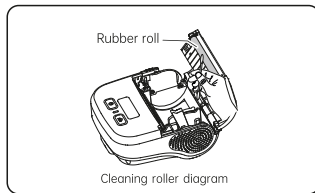

## 4.2 Use and Storage of Printing Paper

1. Please keep newly purchased printing paper in intact package and prevent it from direct sunlight and high temperature.
2. Please keep printed documents in a dark place at room temperature (about 20°C), so as to effectively extend the storage life of the documents.
3. If the documents need to be kept for a long time, please use long-lasting thermal printing paper.

## V. Troubleshooting



Fault phenomenon	Fault cause	Solution
Print on paper only, No data is printed	The printer paper roll is inverted	Please reinstall the printing paper in another direction
1. The print is fuzzy and not clear 2.The printed page is not clear in a vertical column 3.The paper is noisy	1. Print hair black, carbon accumulation is serious 2. The printer is not clean for a long time 3. The printing head and rubber roller are contaminated by dirt	Need to clean the print head and roller (Please refer to P18 Repair and Maintenance for cleaning procedures)
Continuous white paper	Seam mark not recognized	1. long press [paper key] for label learning; 2. Go to the setting screen to learn labels.



## VI. FCC WARNING

---



This device complies with part 15 of the FCC Rules. Operation is subject to the following two conditions: (1) this device may not cause harmful interference, and (2) this device must accept any interference received, including interference that may cause undesired operation.

**NOTE:** This equipment has been tested and found to comply with the limits for a Class A digital device, pursuant to Part 15 of the FCC Rules. These limits are designed to provide reasonable protection against harmful interference when the equipment is operated in a commercial environment. This equipment generates, uses, and can radiate radio frequency energy and, if not installed and used in accordance with the instruction manual, may cause harmful interference to radio communications. Operation of this equipment in a residential area is likely to cause harmful interference in which case the user will be required to correct the interference at his own expense.

### WARNING

Changes or modifications not expressly approved by the party responsible for compliance could void the user's authority to operate the equipment. This equipment complies with FCC radiation exposure limits set forth for an uncontrolled environment.

## VII. Battery recycling

---

This product uses a rechargeable lithium battery. To protect the environment, please do not dispose of used batteries at will. The supplier will provide you with battery recycling service.



### **Rongta Technology (Xiamen) Group Co., Ltd.**

ADD: No.88, Tonghui South Road, Tongan, Xiamen, China.

WEB: [www.rongtatech.com](http://www.rongtatech.com) TEL: 0086-592-5666129

FAX: 0086-592-5659169